



## for Rising Third Graders

**Please use this packet to practice your cursive handwriting. You will be expected to write in cursive for many assignments in third grade. This will be due on the first day of school.**

**Name** \_\_\_\_\_



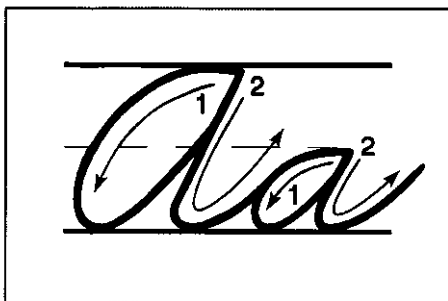

Name: \_\_\_\_\_ Date: \_\_\_\_\_

**Capital A:** Trace the first line and then copy on the lines that follow.

A A A A A A A A

**Lowercase a:** Trace the first line and then copy on the line that follows.

a a a a a a a a a a a a a a a

Aa Aa Aa Aa Aa Aa Aa Aa

**Sentence Writing:** Trace the sentence and then copy it on the line below.

Axl ate all the awesome apples.

Alexi answered annoyingly.

**Writing Words:** Trace each word and then copy it on the lines below.

are

actually

are

ahoy

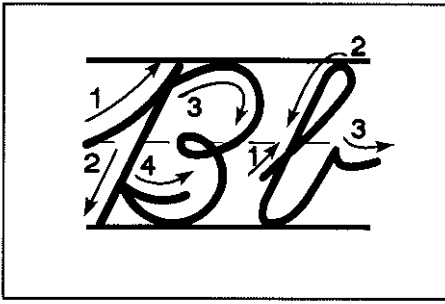

Name: \_\_\_\_\_ Date: \_\_\_\_\_

**CAPITAL B:** Trace the first line and then copy on the lines that follow.

B B B B B B B B

**Lowercase b:** Trace the first line and then copy on the line that follows.

b b b b b b b b b b b b b b b b

Bb Bb Bb Bb Bb Bb Bb Bb Bb

**SENTENCE WRITING:** Trace the sentence and then copy it on the line below.

Bobby brought brown burritos.

Betsy built boxy blue buildings

**WRITING WORDS:** Trace each word and then copy it on the lines below.

busy boring boycott bully

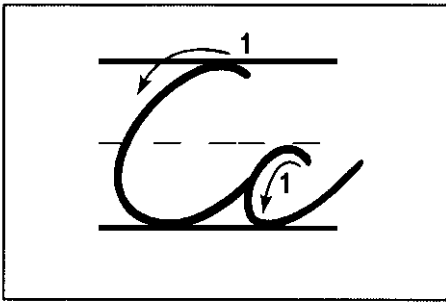

Name: \_\_\_\_\_ Date: \_\_\_\_\_

**Capital C:** Trace the first line and then copy on the lines that follow.

C C C C C C C C C

**Lowercase c:** Trace the first line and then copy on the line that follows.

c c

Cc Cc Cc Cc Cc Cc Cc Cc Cc Cc

**Sentence Writing:** Trace the sentence and then copy it on the line below.

Carlos carried chopped carrots.

Caroline cracked complex codes.

**Writing words:** Trace each word and then copy it on the lines below.

cots      oranges      clipped      chirp

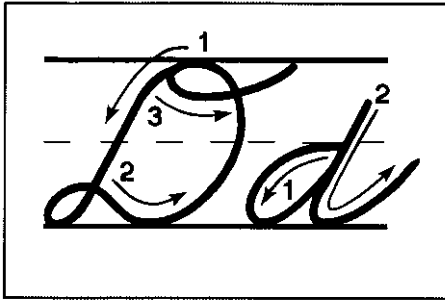

Name: \_\_\_\_\_ Date: \_\_\_\_\_

**CAPITAL D:** Trace the first line and then copy on the lines that follow.

*D D D D D D D*

**Lowercase d:** Trace the first line and then copy on the line that follows.

*d d d d d d d d d d d d d d d*

*Dd Dd Dd Dd Dd Dd Dd*

**SENTENCE WRITING:** Trace the sentence and then copy it on the line below.

*Danny dunked dull donuts.*

*Dizzy dwarfs decoded diaries.*

**Writing Words:** Trace each word and then copy it on the lines below.

*dry*      *drown*      *divide*      *delete*

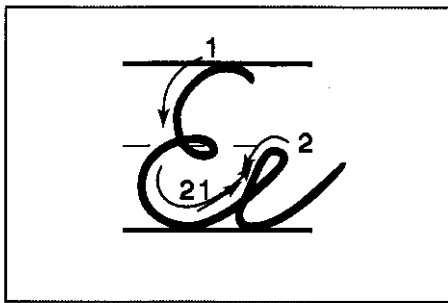

Name: \_\_\_\_\_ Date: \_\_\_\_\_

**Capital E:** Trace the first line and then copy on the lines that follow.

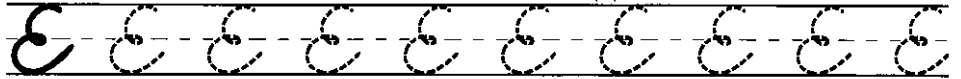

**Lowercase e:** Trace the first line and then copy on the line that follows.

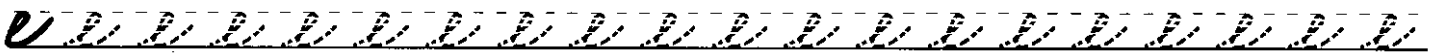

**Sentence Writing:** Trace the sentence and then copy it on the line below.

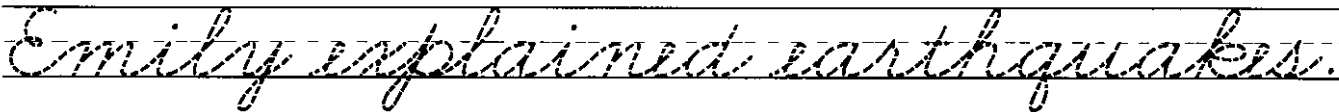
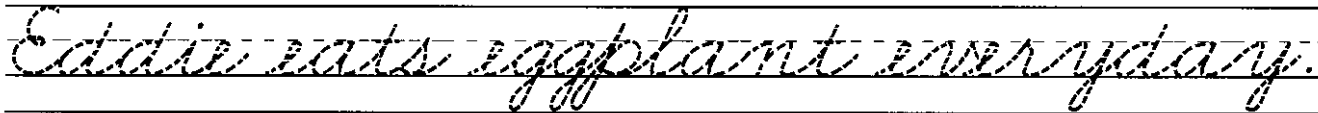

**Writing Words:** Trace each word and then copy it on the lines below.

*even*

*empty*

*Earth*

*extra*

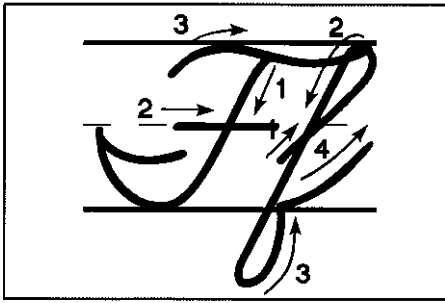

Name: \_\_\_\_\_ Date: \_\_\_\_\_

**CAPITAL F:** Trace the first line and then copy on the lines that follow.



**Lowercase f:** Trace the first line and then copy on the line that follows.

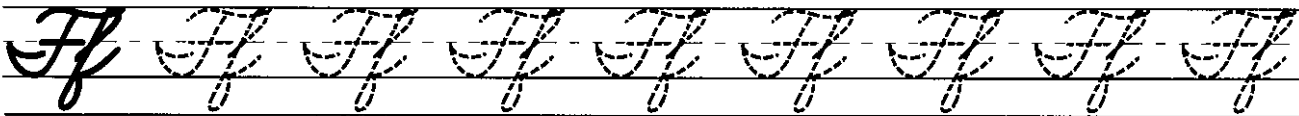
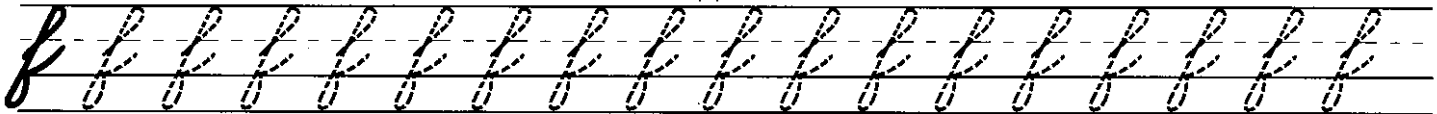

**SENTENCE WRITING:** Trace the sentence and then copy it on the line below.

Fragrant flowers fill fields.

Fifty filthy flies fly freely.

**WRITING WORDS:** Trace each word and then copy it on the lines below.

force

flushes

Frank

fairy



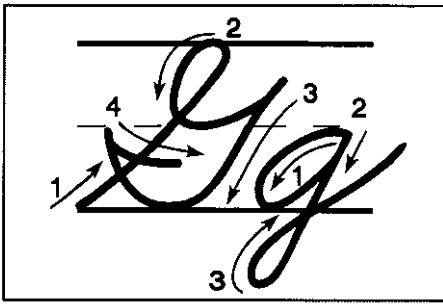

Name: \_\_\_\_\_ Date: \_\_\_\_\_

**CAPITAL G:** Trace the first line and then copy on the lines that follow.

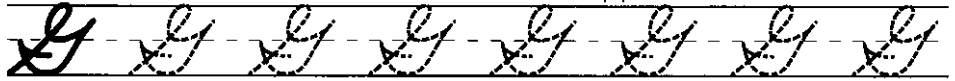

**Lowercase g:** Trace the first line and then copy on the line that follows.

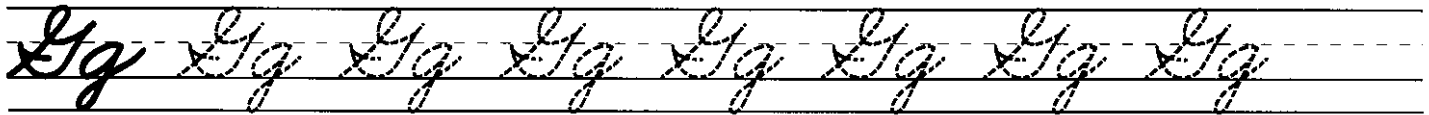
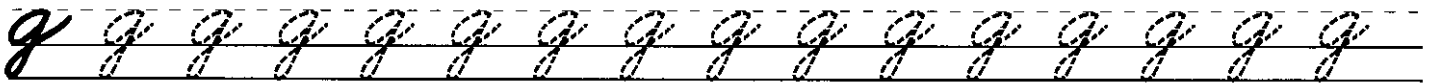

**SENTENCE WRITING:** Trace the sentence and then copy it on the line below.

Giant Groot grilled ginger.

Goofy ghosts guarded grapes.

**WRITING WORDS:** Trace each word and then copy it on the lines below.

gets      grandpa      goo      gunk

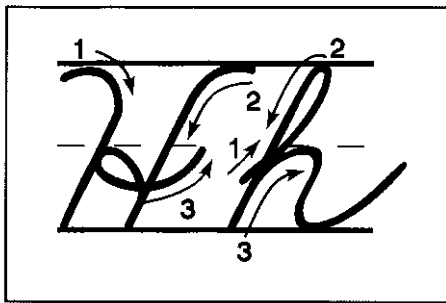

Name: \_\_\_\_\_ Date: \_\_\_\_\_

**Capital H:** Trace the first line and then copy on the lines that follow.

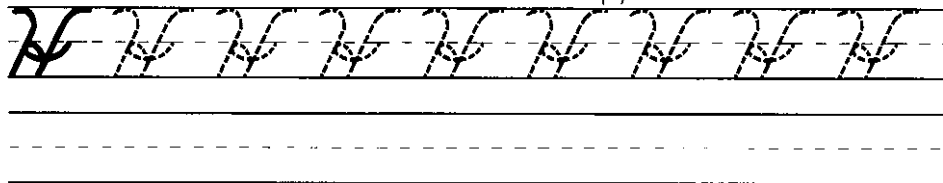

**Lowercase h:** Trace the first line and then copy on the line that follows.

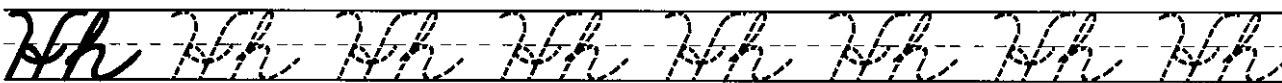
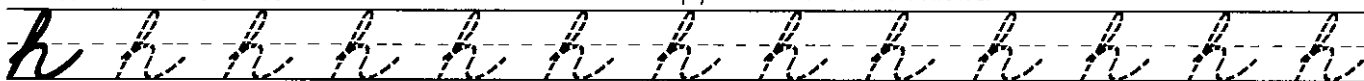

**Sentence Writing:** Trace the sentence and then copy it on the line below.

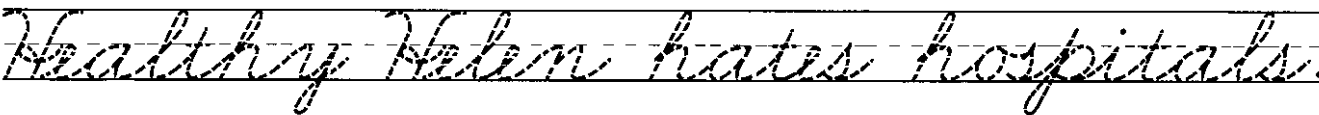
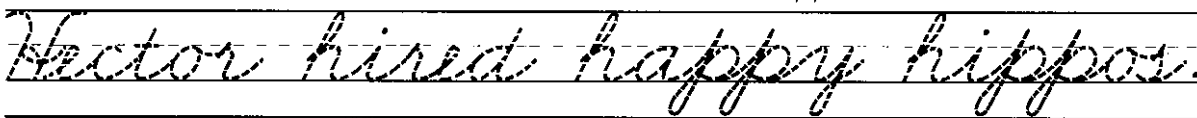

**Writing Words:** Trace each word and then copy it on the lines below.

hide

hooray

hunger

hello

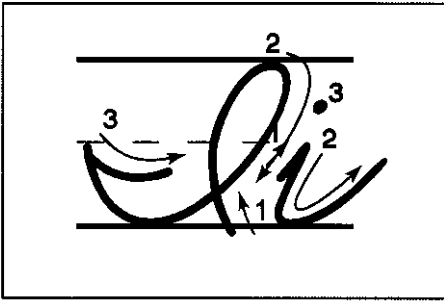

Name: \_\_\_\_\_ Date: \_\_\_\_\_

**Capital I:** Trace the first line and then copy on the lines that follow.

*I I I I I I I I*

**Lowercase i:** Trace the first line and then copy on the line that follows.

*i i i i i i i i i i i i i i i i*

*li li li li li li li li li*

**Sentence Writing:** Trace the sentence and then copy it on the line below.

*Itchy iguanas invade igloos.*

*Invisible insects infest Ikea.*

**Writing Words:** Trace each word and then copy it on the lines below.

*iced*

*idioms*

*import*

*issues*

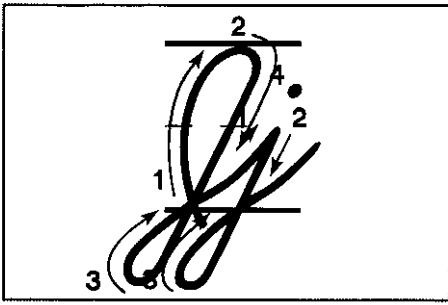

Name: \_\_\_\_\_ Date: \_\_\_\_\_

**Capital J:** Trace the first line and then copy on the lines that follow.

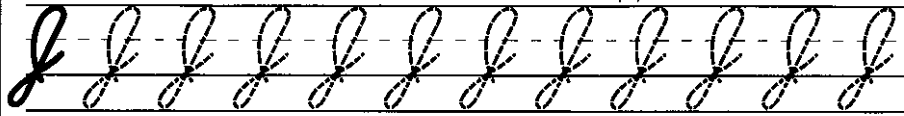

**Lowercase j:** Trace the first line and then copy on the line that follows.

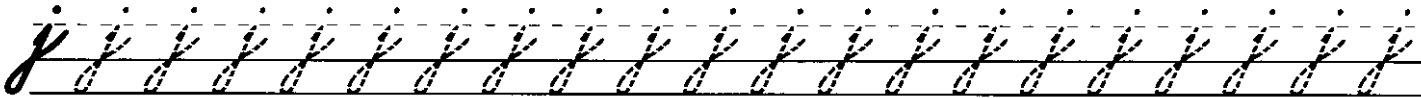

**Sentence Writing:** Trace the sentence and then copy it on the line below.

joyful jay juggles jlyteans.

Jane jackhammers jicamas.

**Writing Words:** Trace each word and then copy it on the lines below.

joys

Jupiter

jackets

juicy

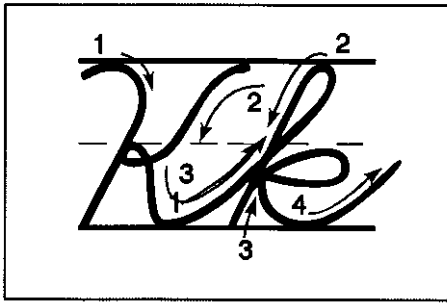

Name: \_\_\_\_\_ Date: \_\_\_\_\_

**Capital K:** Trace the first line and then copy on the lines that follow.

*K K K K K K K K K K*

**Lowercase k:** Trace the first line and then copy on the line that follows.

*k k k k k k k k k k k k k k*

*Kk Kk Kk Kk Kk Kk Kk Kk*

**Sentence Writing:** Trace the sentence and then copy it on the line below.

*Karen knows kind knights.*

*Koalas kidnap kookaburras.*

**Writing Words:** Trace each word and then copy it on the lines below.

*keys*

*kazoo*

*keypad*

*knife*

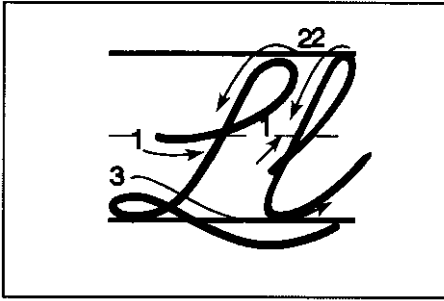

Name: \_\_\_\_\_ Date: \_\_\_\_\_

**Capital L:** Trace the first line and then copy on the lines that follow.

L L L L L L L L L L

**Lowercase l:** Trace the first line and then copy on the line that follows.

l l l l l l l l l l l l l l l l

Ll Ll Ll Ll Ll Ll Ll Ll Ll Ll

**Sentence Writing:** Trace the sentence and then copy it on the line below.

Lazy Leo licks lucky lollipops.

Lucy loves learning languages.

**Writing Words:** Trace each word and then copy it on the lines below.

late lemons lobsters litter

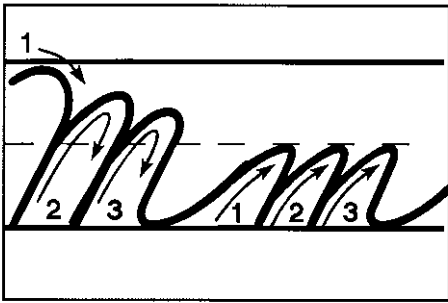

Name: \_\_\_\_\_ Date: \_\_\_\_\_

**CAPITAL M:** Trace the first line and then copy on the lines that follow.

M M M M M M M M

**Lowercase m:** Trace the first line and then copy on the line that follows.

m m m m m m m m m m

Mm Mm Mm Mm Mm Mm

**SENTENCE WRITING:** Trace the sentence and then copy it on the line below.

Monkeys munch on muffins.

Madison moves many mugs.

**WRITING WORDS:** Trace each word and then copy it on the lines below.

mix moments my meme

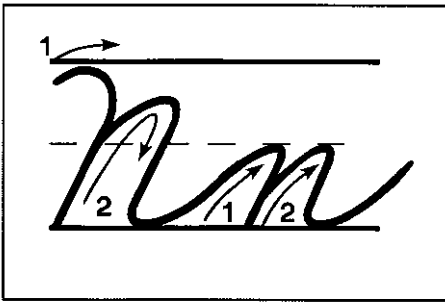

Name: \_\_\_\_\_ Date: \_\_\_\_\_

**CAPITAL N:** Trace the first line and then copy on the lines that follow.

*N N N N N N N N N*

**Lowercase n:** Trace the first line and then copy on the line that follows.

*n n n n n n n n n n n n n*

*Nn Nn Nn Nn Nn Nn Nn Nn*

**SENTENCE WRITING:** Trace the sentence and then copy it on the line below.

*Nine noisy nouns nod nicely.*

*Nervous Nate nurtures newts.*

**WRITING WORDS:** Trace each word and then copy it on the lines below.

*not*

*nugget*

*nickels*

*nurse*



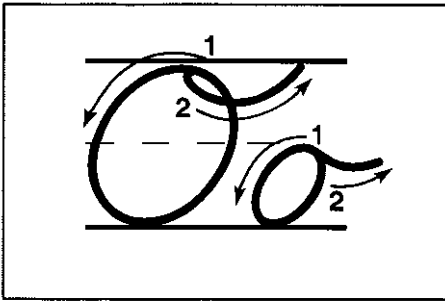

Name: \_\_\_\_\_ Date: \_\_\_\_\_

**Capital O:** Trace the first line and then copy on the lines that follow.

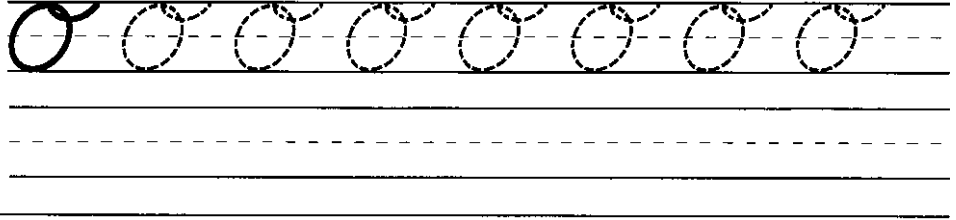

**Lowercase o:** Trace the first line and then copy on the line that follows.

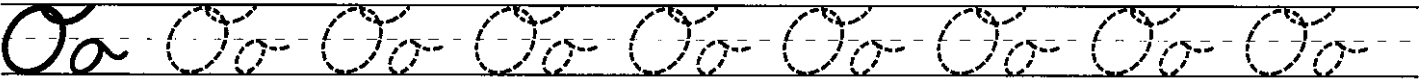
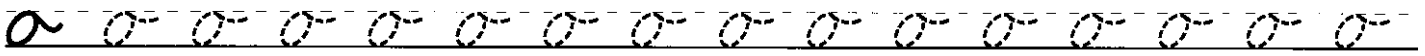

**Sentence Writing:** Trace the sentence and then copy it on the line below.

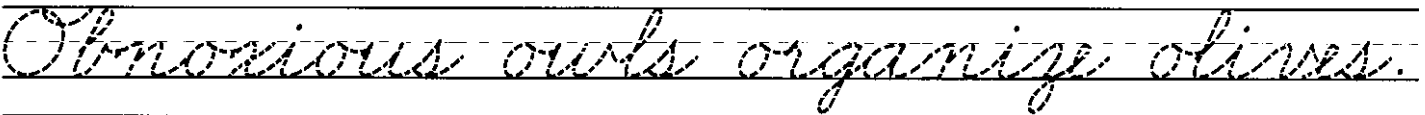
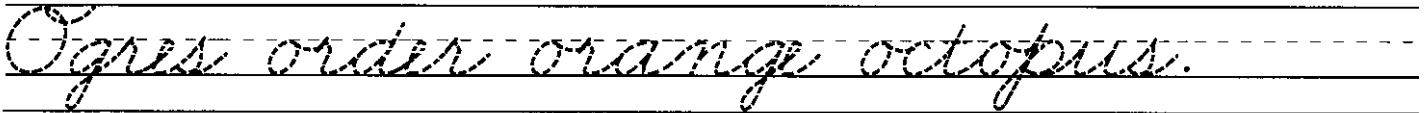

**Writing Words:** Trace each word and then copy it on the lines below.

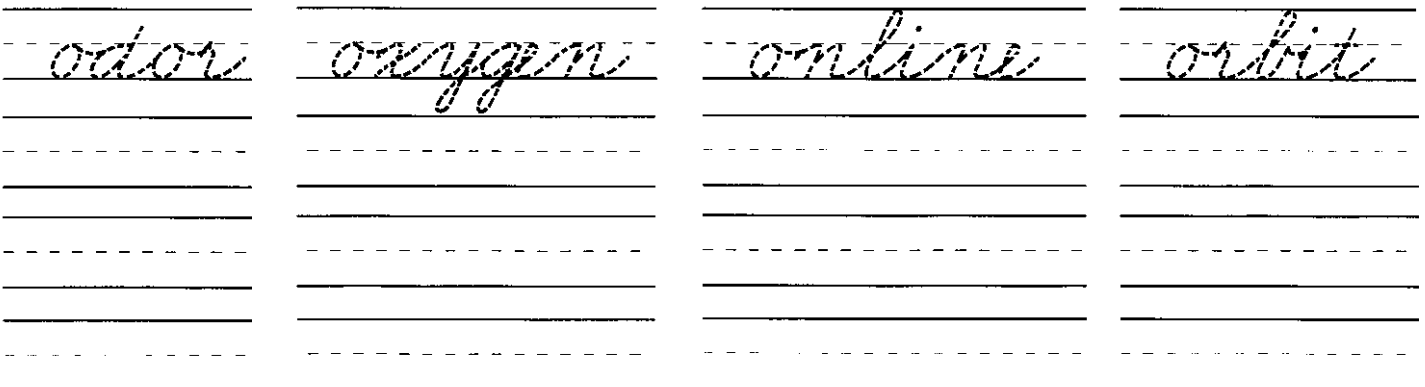

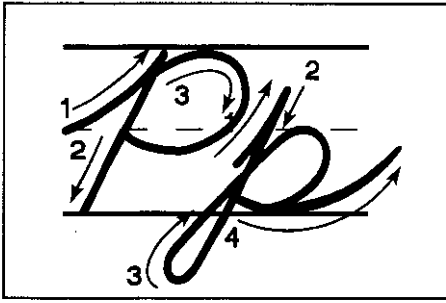

Name: \_\_\_\_\_ Date: \_\_\_\_\_

**Capital P:** Trace the first line and then copy on the lines that follow.

P P P P P P P P

**Lowercase p:** Trace the first line and then copy on the line that follows.

p p p p p p p p p p p p p p

Pp Pp Pp Pp Pp Pp Pp Pp

**Sentence Writing:** Trace the sentence and then copy it on the line below.

Porky Pig put pickles on pie.

Princess Peach pinched Peter.

**Writing Words:** Trace each word and then copy it on the lines below.

pits

puffin

pockets

pizza

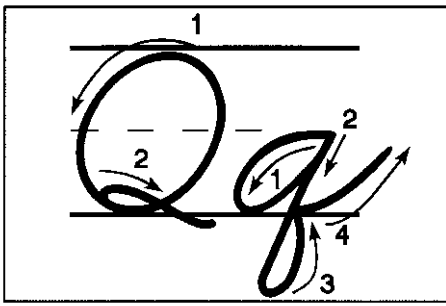

Name: \_\_\_\_\_ Date: \_\_\_\_\_

**Capital Q:** Trace the first line and then copy on the lines that follow.

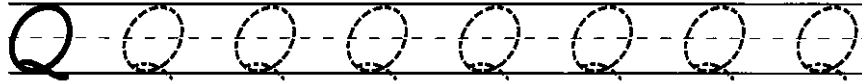

**Lowercase q:** Trace the first line and then copy on the line that follows.

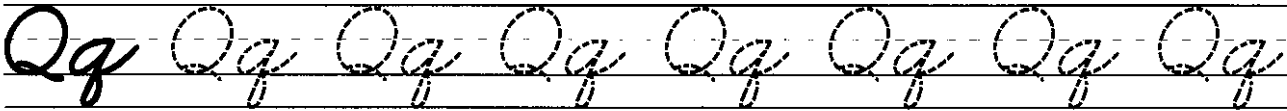
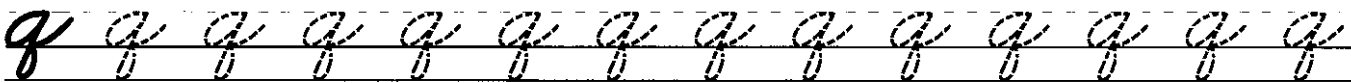

**Sentence Writing:** Trace the sentence and then copy it on the line below.

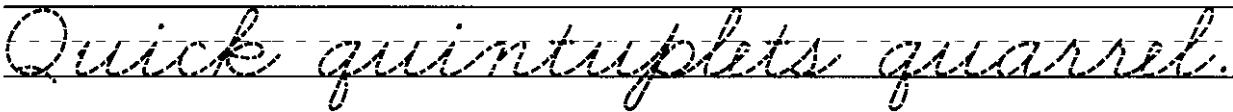
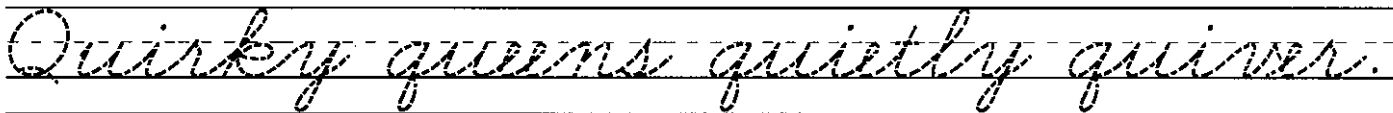

**Writing Words:** Trace each word and then copy it on the lines below.

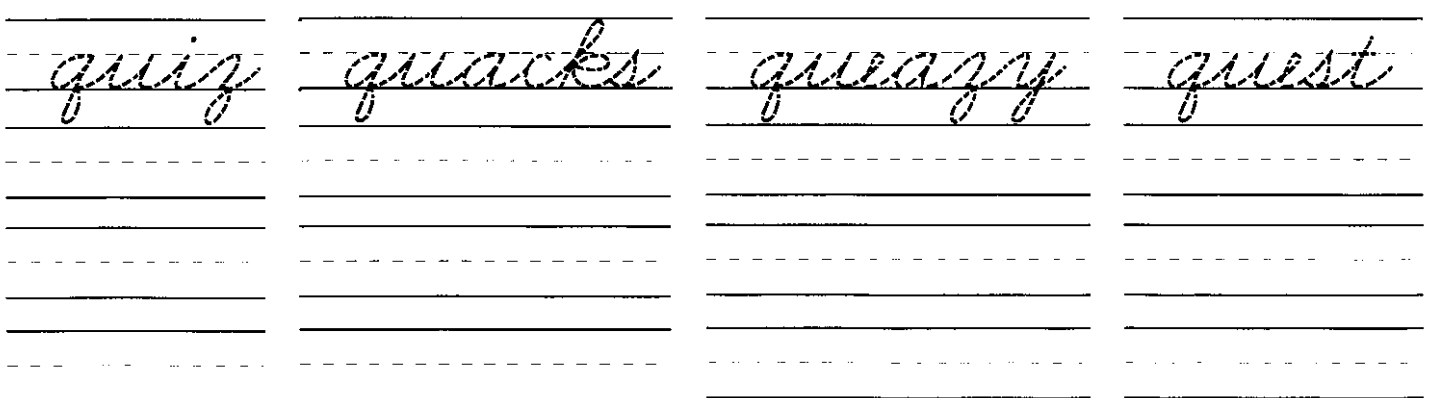

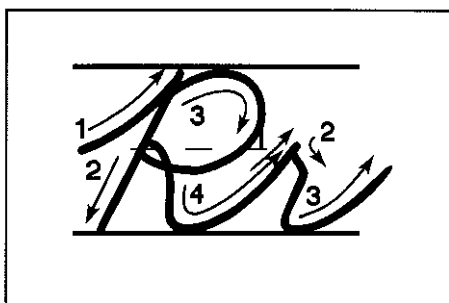

Name: \_\_\_\_\_ Date: \_\_\_\_\_

**Capital R:** Trace the first line and then copy on the lines that follow.

R R R R R R R R R

**Lowercase r:** Trace the first line and then copy on the line that follows.

r r r r r r r r r r r r r r r r r

Rr Rr Rr Rr Rr Rr Rr Rr

**Sentence Writing:** Trace the sentence and then copy it on the line below.

Rose recorded running rabbits.

Rocky rejected royal red rhinos.

**Writing Words:** Trace each word and then copy it on the lines below.

rock

regular

rarely

right

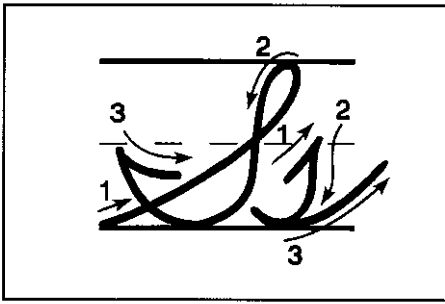

Name: \_\_\_\_\_ Date: \_\_\_\_\_

**Capital S:** Trace the first line and then copy on the lines that follow.



**Lowercase s:** Trace the first line and then copy on the line that follows.

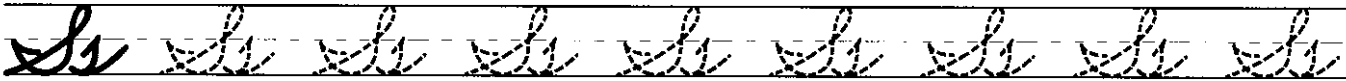

**Sentence Writing:** Trace the sentence and then copy it on the line below.

*Silly Suzzy's sloths snore.*

*Slow slugs sleepwalk silently.*

**Writing Words:** Trace each word and then copy it on the lines below.

*sobs*

*sunshine*

*slide*

*shoes*

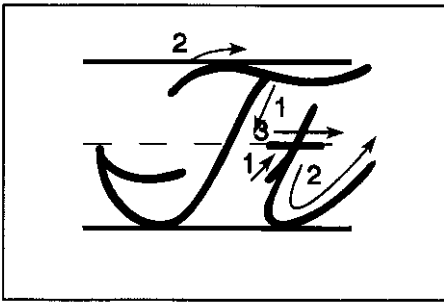

Name: \_\_\_\_\_ Date: \_\_\_\_\_

**CAPITAL T:** Trace the first line and then copy on the lines that follow.

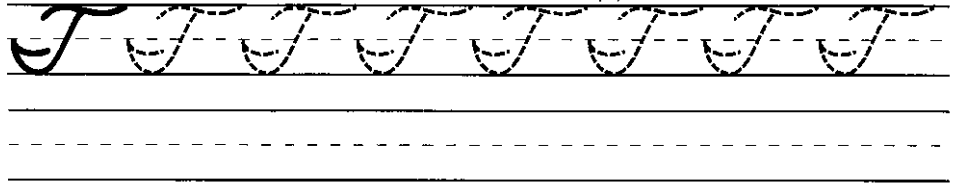

**Lowercase t:** Trace the first line and then copy on the line that follows.

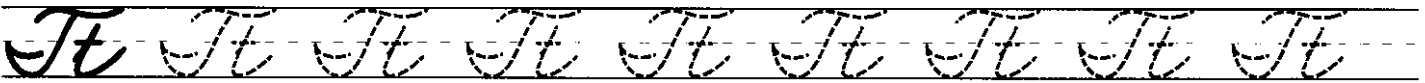
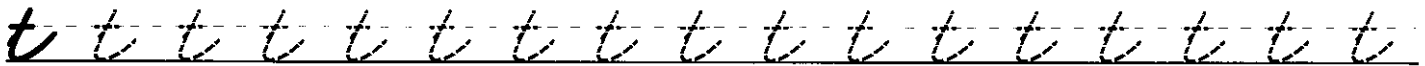

**SENTENCE WRITING:** Trace the sentence and then copy it on the line below.

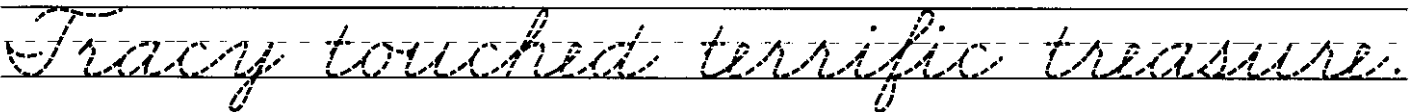
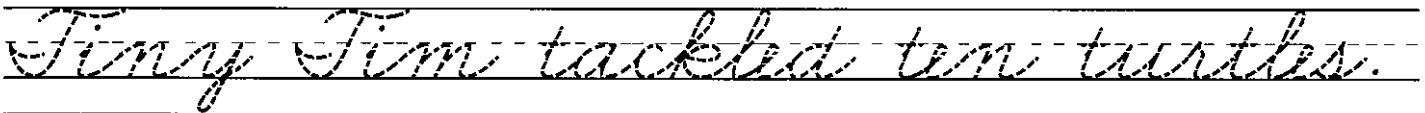

**WRITING WORDS:** Trace each word and then copy it on the lines below.

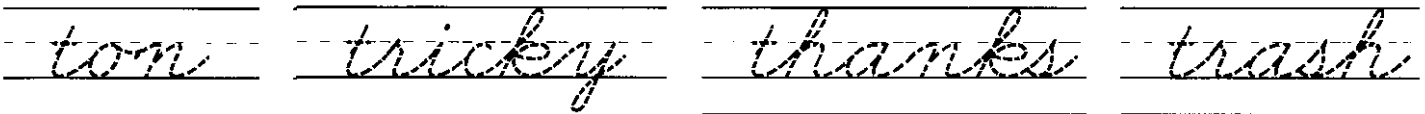



Name: \_\_\_\_\_ Date: \_\_\_\_\_

**Capital U:** Trace the first line and then copy on the lines that follow.

U U U U U U U U U U

**Lowercase u:** Trace the first line and then copy on the line that follows.

u u u u u u u u u u u u

Uu Uu Uu Uu Uu Uu Uu Uu

**sentence writing:** Trace the sentence and then copy it on the line below.

Ursula unfroze ugly unicorns.

Umpires unwrap uniforms.

**Writing words:** Trace each word and then copy it on the lines below.

used unclog upset ultra

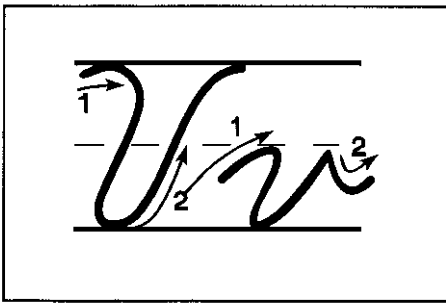

Name: \_\_\_\_\_ Date: \_\_\_\_\_

**CAPITAL V:** Trace the first line and then copy on the lines that follow.

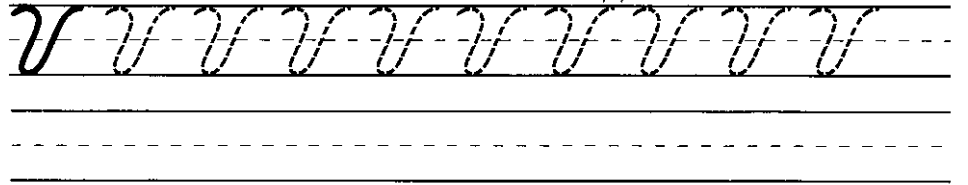

**Lowercase v:** Trace the first line and then copy on the line that follows.

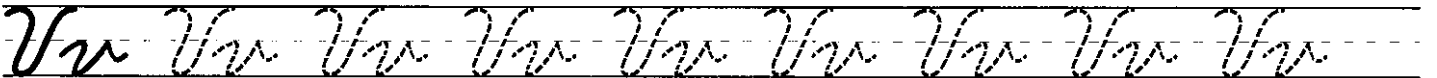
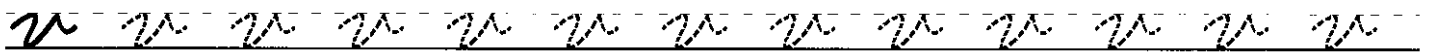

**SENTENCE WRITING:** Trace the sentence and then copy it on the line below.

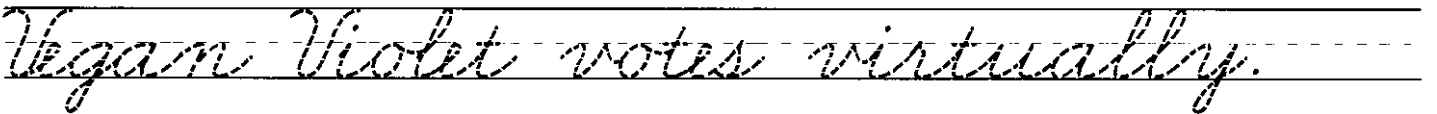
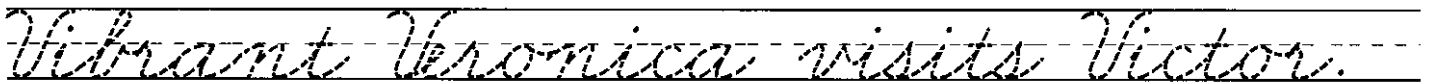

**WRITING WORDS:** Trace each word and then copy it on the lines below.

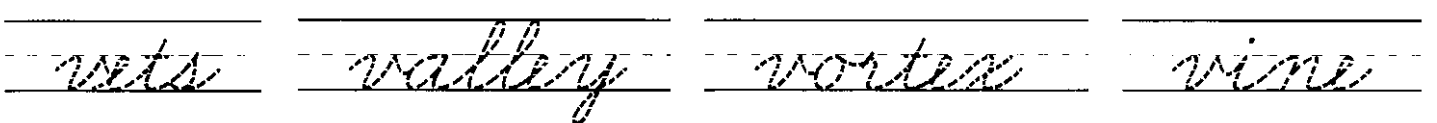





Name: \_\_\_\_\_ Date: \_\_\_\_\_

**Capital W:** Trace the first line and then copy on the lines that follow.

W W W W W W W W W W W W W W W W

**Lowercase w:** Trace the first line and then copy on the line that follows.

w w w w w w w w w w w w w w w w

Ww Ww Ww Ww Ww Ww Ww Ww

**Sentence Writing:** Trace the sentence and then copy it on the line below.

Where would Wookies work?

Weepy Woody writes wise words.

**Writing Words:** Trace each word and then copy it on the lines below.

wet wacky whoops weird

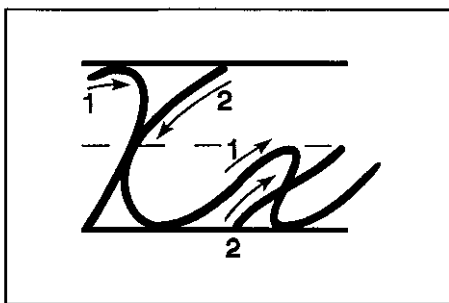

Name: \_\_\_\_\_ Date: \_\_\_\_\_

**Capital X:** Trace the first line and then copy on the lines that follow.

X X X X X X X X X X

**Lowercase x:** Trace the first line and then copy on the line that follows.

x x x x x x x x x x x x x x

Xx Xx Xx Xx Xx Xx Xx Xx Xx

**Sentence Writing:** Trace the sentence and then copy it on the line below.

X-Men xerox xylophones.

**Writing Words:** Trace each word and then copy it on the lines below.

Xerox xenopus xylophone xylophone

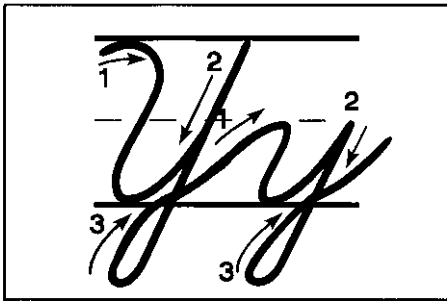

Name: \_\_\_\_\_ Date: \_\_\_\_\_

**CAPITAL Y:** Trace the first line and then copy on the lines that follow.

Y Y Y Y Y Y Y Y Y Y Y

**Lowercase y:** Trace the first line and then copy on the line that follows.

y y y y y y y y y y y

Yy Yy Yy Yy Yy Yy Yy Yy Yy

**SENTENCE WRITING:** Trace the sentence and then copy it on the line below.

Young YouTubers yell, "Yellow".

Young Yeti's yodeled yesterday.

**WRITING WORDS:** Trace each word and then copy it on the lines below.

yak

yearbook

yay

yoga

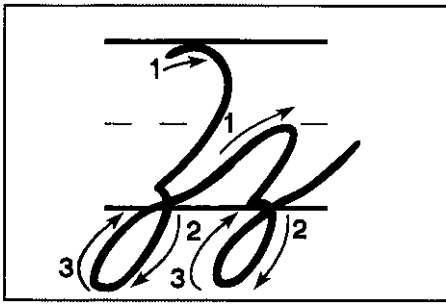

Name: \_\_\_\_\_ Date: \_\_\_\_\_

**CAPITAL Z:** Trace the first line and then copy on the lines that follow.

*Z Z Z Z Z Z Z Z Z Z Z Z*

**Lowercase z:** Trace the first line and then copy on the line that follows.

*z z z z z z z z z z z z z z z z*

*zz zz zz zz zz zz zz zz zz zz*

**SENTENCE WRITING:** Trace the sentence and then copy it on the line below.

*Joey zips zany zombie zippers.*

*Zeppelins zoom to the zoo.*

**WRITING WORDS:** Trace each word and then copy it on the lines below.

*busy*

*boring*

*boycott*

*bully*